

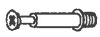





A	x40
	
M6*35mm	

B	x40
	
φ 15*10mm	

C	x16
	
M6*30mm	

D	x22
	
M4*35mm	

E	x48
	
M3.5*12mm	

F	x4
	

G	x8
	
M3*16mm	



H	x2
	

I	x2
	

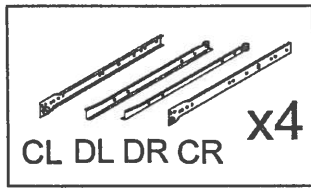

J	x2
	
M4*12mm	

K	x8
	

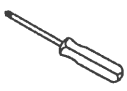
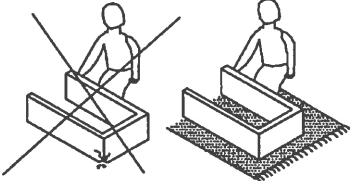

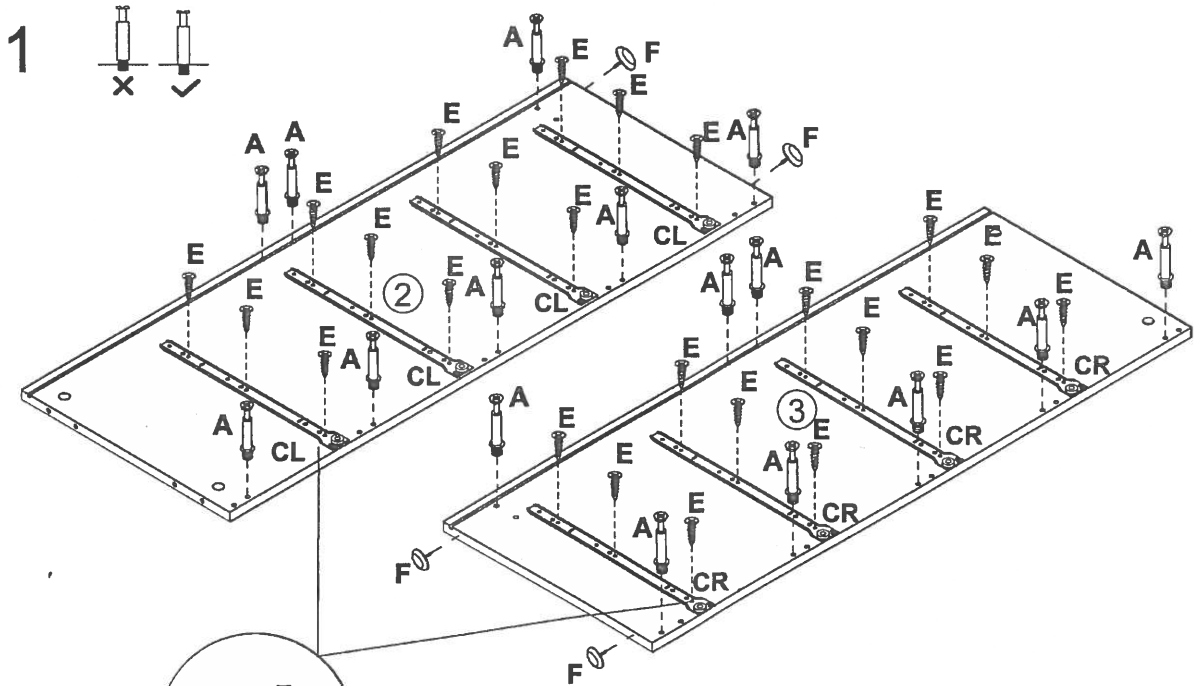

 45 MIN		 NOT PROVIDED	
---	--	---	---



		x4
---	---	-----------



A	x16
	

E	x24
	

F	x4
	

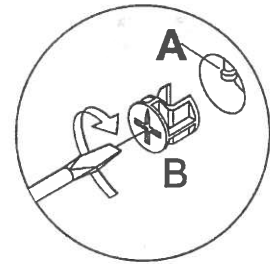
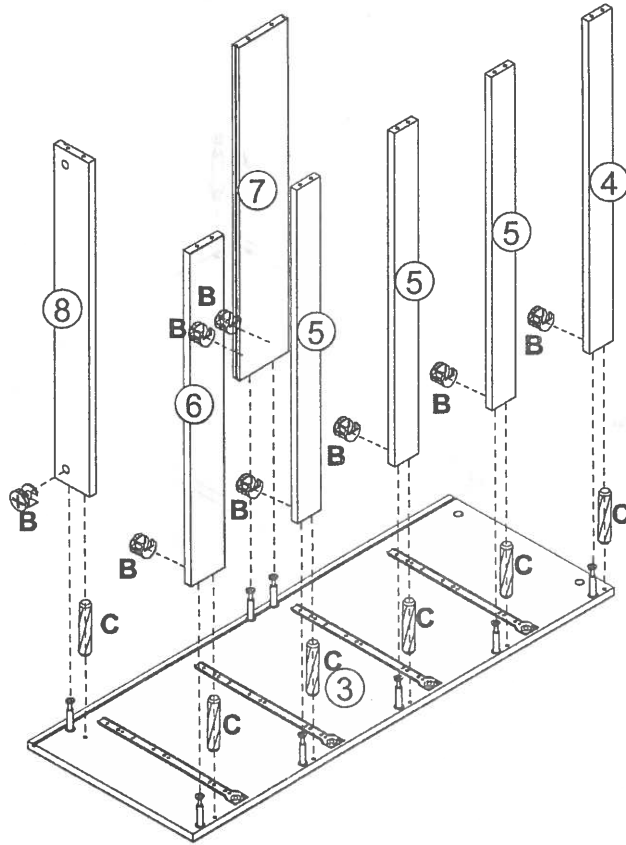

2

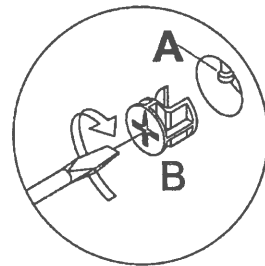
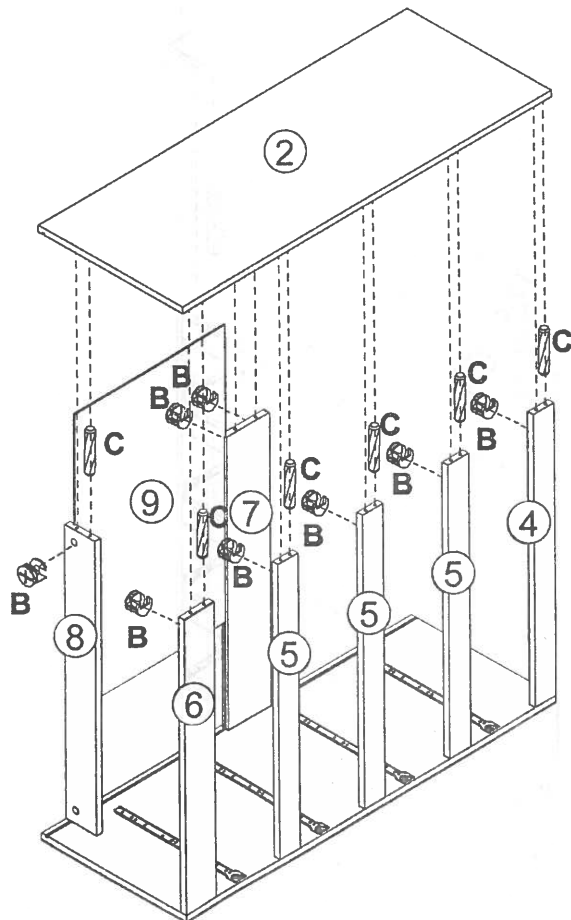

B	x8	C	x6
			

3



B	x8	C	x6
			

4

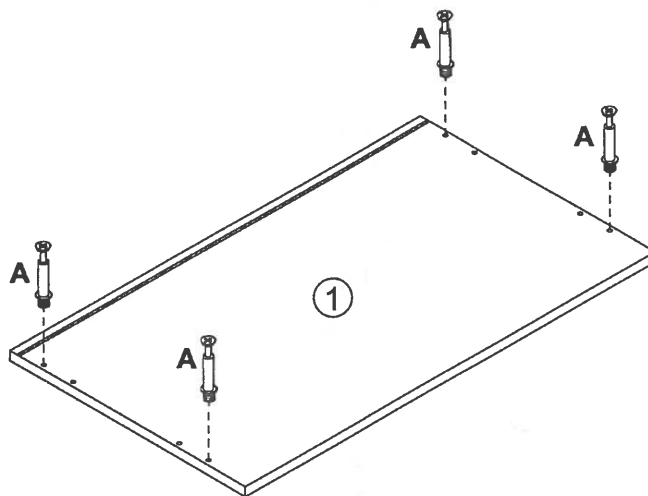
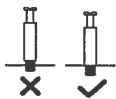

A	x4

5

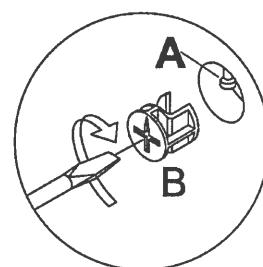
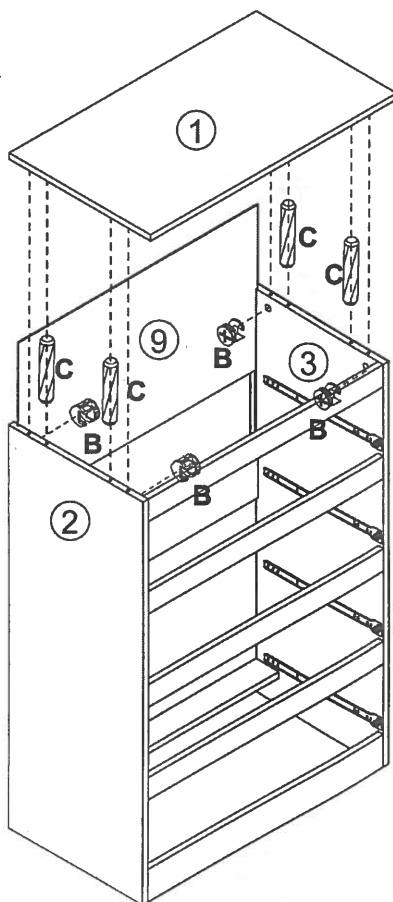





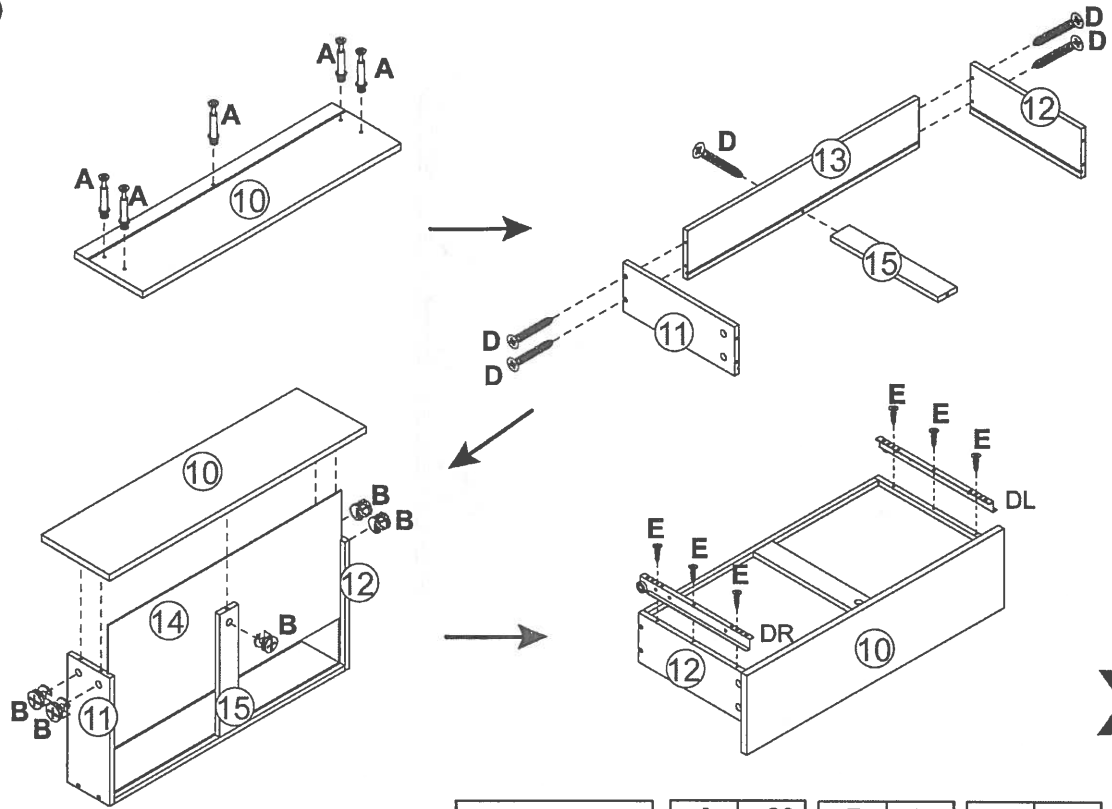







B	x4	C	x4

6



x4

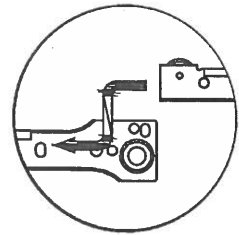
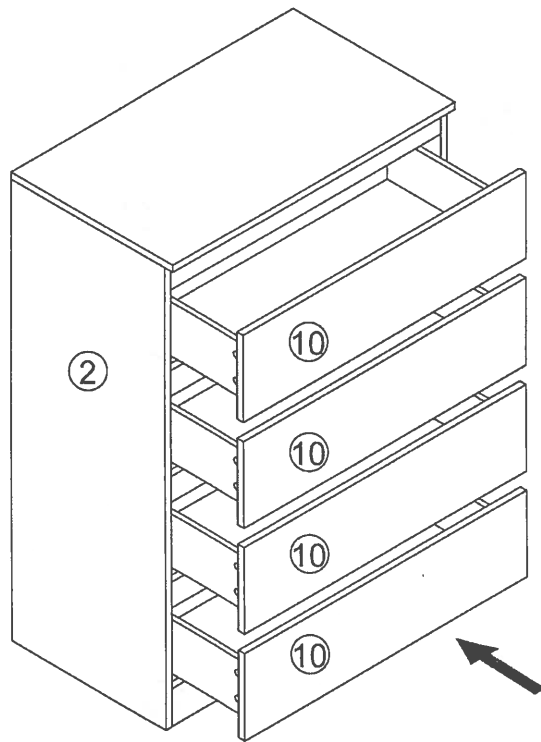

 <p>DL DR x4</p>	<table border="1"> <tr> <td>A</td> <td>x20</td> </tr> <tr> <td></td> <td></td> </tr> </table>	A	x20			<table border="1"> <tr> <td>B</td> <td>x20</td> </tr> <tr> <td></td> <td></td> </tr> </table>	B	x20			<table border="1"> <tr> <td>D</td> <td>x20</td> </tr> <tr> <td></td> <td></td> </tr> </table>	D	x20			<table border="1"> <tr> <td>E</td> <td>x24</td> </tr> <tr> <td></td> <td></td> </tr> </table>	E	x24		
A	x20																			
																				
B	x20																			
																				
D	x20																			
																				
E	x24																			
																				

7

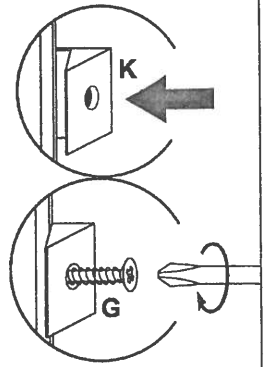
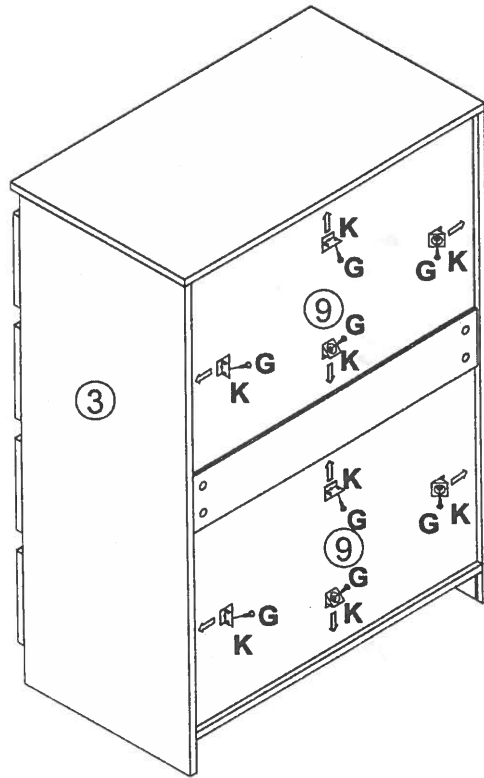

8



K	x8		x8
			

9

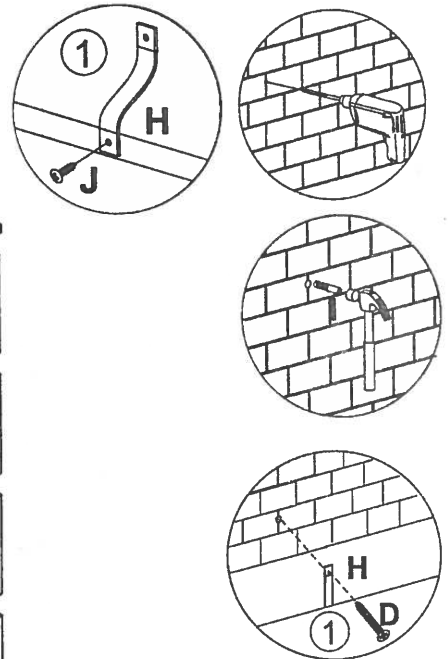
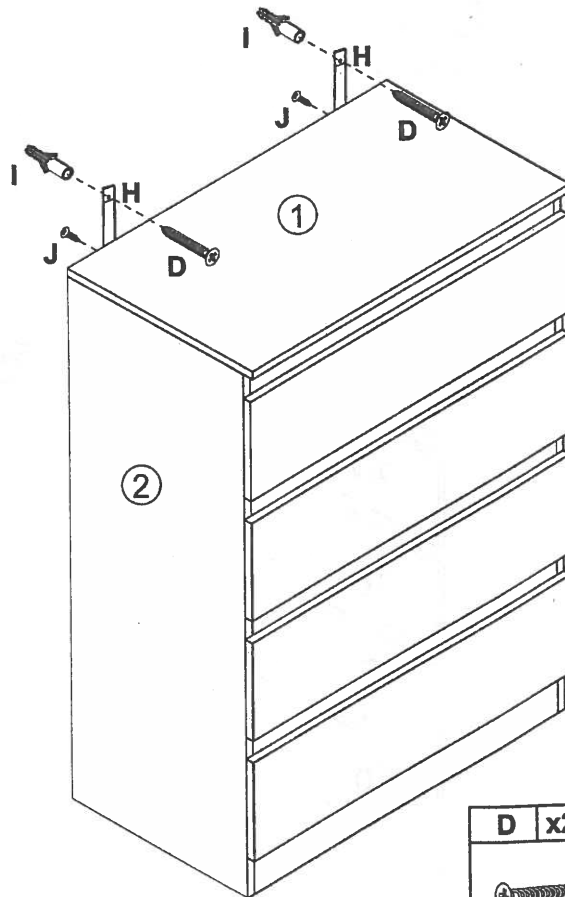

D	x2	J	x2	H	x2	I	x2
